



Polarographic Amplifier

1900

INSTRUCTION MANUAL
FOR
POLAROGRAPHIC AMPLIFIER
MODEL 1900

Serial # _____

Date _____

A-M Systems
PO Box 850
Carlsborg, WA 98324
U.S.A.

360-683-8300 ♦ 800-426-1306 FAX:

360-683-3525

<http://www.a-msystems.com>

Version 9.0
March 2020

Contents

General Description	1
Instrument Features	1
Controls and Connectors.....	2
Operating Instructions	4
Polarographic electrodes.....	4
Instrument Set-Up and Calibration.....	6
Problem Solving	9
Theory Of Operation	11
Specifications	13
Warranty and Service	17

Each Polarographic Amplifier is delivered complete with:

Rack Mount Hardware

NOTE

This instrument is not intended for clinical measurements using human subjects. A-M Systems does not assume responsibility for injury or damage due to the misuse of this instrument.

General Description

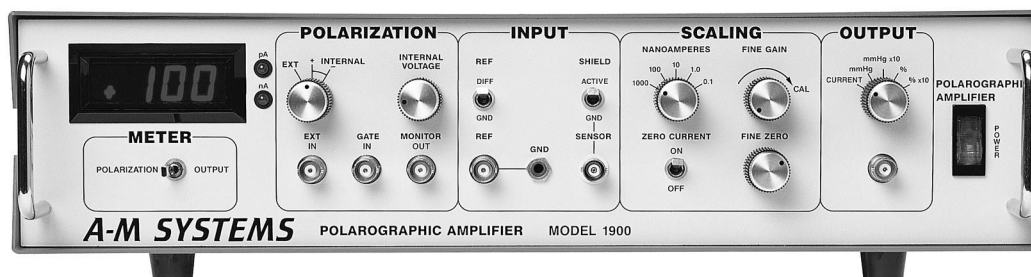

Instrument Features

The *Polarographic Amplifier Model 1900* is designed primarily for use with microelectrodes (such as oxygen and hydrogen electrodes) which produce a current response to an applied polarization voltage in the presence of the sensed gas. The *Model 1900* converts the input current to an output voltage, scaled and offset by user operated controls. The voltage is output for subsequent analysis by the researcher.

The polarization voltage applied to the electrode may be set internally via manual controls or through an external signal source. In either case, the polarization may be turned off by a separate gate signal without disturbing other settings.

No head stage is required to achieve very low bias current (<1 pA, nominal, before adjustment) using an actively-driven shielded sensor cable. Standard BNC connectors are used for all signal connections. The sensor input connector can be operated with a driven shield to minimize cable and connector leakage currents for applications requiring the highest sensitivity; or with a grounded shield for greater convenience in less demanding applications. The reference input may be set to differential or ground. In differential mode, negligible current flows through the reference electrode, eliminating reference electrode IR (voltage drop) errors. In ground mode, the requirement for a separate ground electrode is eliminated.

The output scaling can be selected to read out in absolute current measured in nA, or in mmHg, expanded 10x mmHg, percentage, or kPa. The input "zero" current may be set up to one fourth of the full scale current range. In this way, any constant leakage current (especially that from electrode current which flows in the absence of any reagent gas) may be readily ignored. The gain is adjustable with step and fine controls. Adjustment of the gain does not require readjustment of the zero current. System sensitivity is high, with a maximum resolution of 0.1pA when in 100 pA scale.

The output can be read directly using an internal digital meter (3 1/2 digits), and can be connected to chart recorders, FM tape recorders, or computers. The digital meter can also be used to measure the polarization voltage.

Controls and Connectors

The *Model 1900* has been designed to ease polarographic measurements, while accommodating the imperfections of real electrodes. This section gives a brief description of the controls and connectors.

INPUT

The **INPUT** section is directly associated with the electrodes. The sensing electrode is connected to the **SENSOR** input. The reference electrode is connected to the **REF** input. While the shield of the **REF** input connector is permanently attached to ground, the shield of the **SENSOR** input may be grounded (**GND**) via the **SHIELD** switch or may be actively driven (**ACTIVE**), in order to reduce leakage currents in the interconnecting hardware. The **REF** input itself may be connected to ground (**GND**) via the **REF** switch, or the amplifier may be operated differentially (**DIFF**).

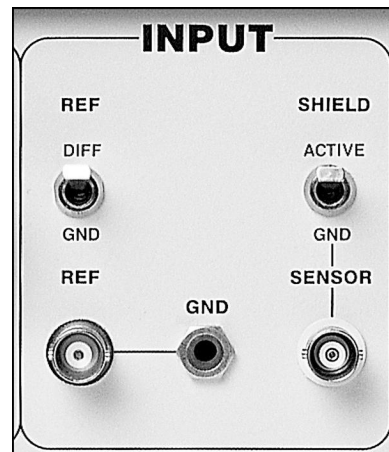

POLARIZATION

The **POLARIZATION** section controls are used to bias the sensing electrode at the required potential relative to the reference, whether the reference is at ground or operating differentially. The polarization voltage source can be set to **EXTERNAL**, **INTERNAL+**, or **INTERNAL -**, with a rotary switch. An external polarization voltage source is connected to the **EXT IN** connector. Alternatively, an **INTERNAL** polarization voltage level is set with the **INTERNAL VOLTAGE** control. Whatever the source, the polarization voltage may be turned on or off using a gate signal applied to the **GATE IN** connector. The applied polarization voltage may also be monitored externally at the **MONITOR OUT** connector.

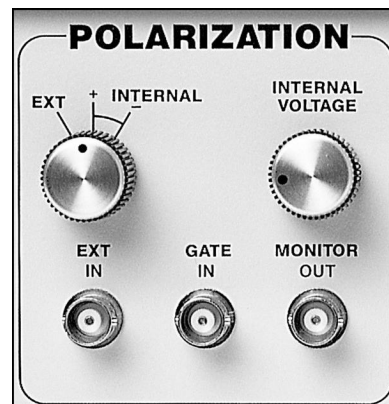

SCALING

The **SCALING** section provides control over the gain and offset settings. Offset is controlled by the **FINE ZERO** control, which may be switched **ON** or **OFF** with the **ZERO CURRENT** switch. The gain is controlled in steps by the **NANOAMPERS** rotary switch, and continuously over a narrower range by the **FINE GAIN** control.



OUTPUT

The form of the output is controlled by the **OUTPUT** selector switch. In the **CURRENT** mode, the measurements are absolute (not sign adjusted). An additional x10 gain (expansion gain) is inserted in the **mmHg x10** and **% x10** modes for increased resolution with small currents. The decimal point of the panel meter is shifted, maintaining the original sense of the measurement, while providing the higher resolution. The output voltage is available externally via the BNC connector for continuous recording with a chart recorder, or computerized data acquisition equipment.

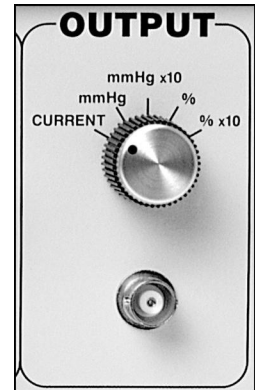

METER

The **METER** may be used to monitor either the **POLARIZATION** voltage (unaffected by the **GATE IN** signal), or the **OUTPUT** voltage. **pA** and **nA** indicators supplement the decimal point location on the **METER** to provide a 5-decade sensitivity range without loss of resolution.

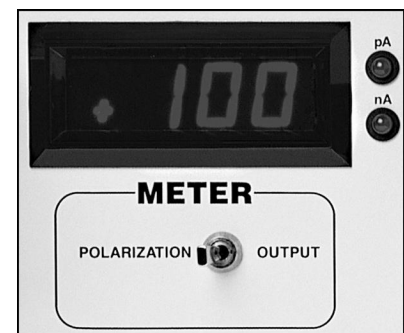

Operating Instructions

The *Model 1900* has been designed to be simple and intuitive to operate, while allowing a high degree of flexibility and performance. A brief description of pertinent polarographic electrode characteristics is included in this section along with operating instructions for the instrument and solutions to common problems which are encountered in its use, in order to assist with the effective use of this instrument.

Polarographic electrodes

The most important property of polarographic electrodes is that their current, instead of their voltage, varies with a change in the concentration of the sensed substance (most commonly a dissolved gas such as oxygen)¹.

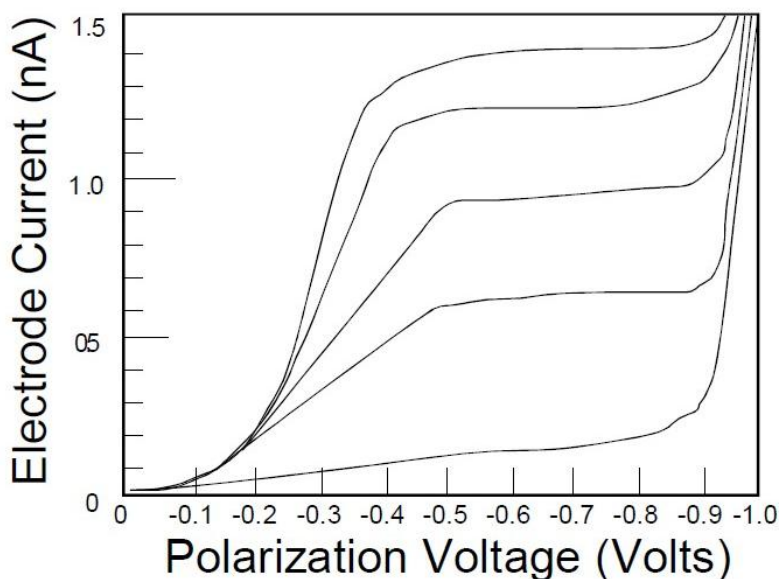

Figure 1. Typical oxygen electrode response

To use such an electrode, a bias voltage is applied which intersects the plateau region(s), allowing the current response to be linear over a physiologically meaningful range. The current amplitude is often extremely small, typically in the nano- or picoampere range. These characteristics require that an amplifier with current-to-voltage capabilities be used in order to measure the concentration of the sensed substance.

¹ . An excellent description of the theory, construction, and application of polarographic electrodes can be found in: Irving Fatt, Polarographic Oxygen Sensor, Malebar FL: Robert E. Kreiger Publishing Co., 1982.

The polarographic electrode can be used as part of a 2 electrode or a 3 electrode configuration (see Figure 2 and Figure 3):

The 2 electrode configuration is simple and convenient. The polarization voltage is impressed across the two electrodes. Notice, however, that the sensed current must flow through the reference electrode. The reference electrode may have an impedance of many MV. In such a case, the IR drop within the reference electrode may be sufficient to bias the polarographic electrode out of the plateau region of the electrode. This problem can be eliminated with the addition of another electrode.

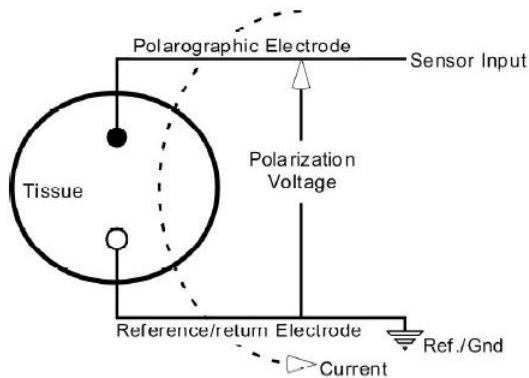

Figure 2. Two-electrode configuration

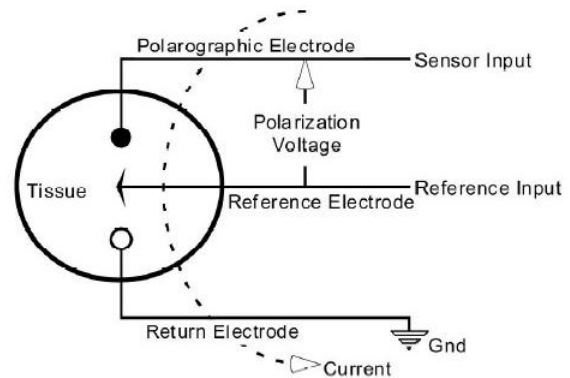

Figure 3. Three-electrode configuration

Using the 3 electrode configuration, the polarographic current now flows through the separate ground return electrode. The placement of the ground return electrode can be almost anywhere, as long as it is in electrical contact with the tissue.² The reference electrode must be close to the tissue being sensed in order that the tissue voltage being sensed by it be accurate. The current sensed is always that which is flowing in the SENSOR lead. This allows flexibility in grounding arrangements.

For either the 2 or 3 electrode configuration, the voltage impressed on the polarographic electrode is the sum of the reference voltage and the polarization voltage. For the 2 electrode configuration, this means that the polarization voltage is relative to ground, which may be offset from the tissue potential by the IR drop in the ground/reference electrode. For the 3 electrode configuration, the polarization voltage is relative to the reference electrode voltage.

² . Some additional consideration may be necessary if the “ground” currents are allowed to be coupled through neural tissues. Unwanted complications may result if these currents stimulate responses. The same considerations apply for the 2 electrode configuration. The amount of current flowing through most polarographic electrodes is low enough that this should not be a problem for nearly all researchers.

Instrument Set-Up and Calibration

Note: In most cases, the settings of the Model 1900 will not have to be changed from experiment to experiment, except for calibrating the electrodes.

Connecting the Electrodes to the Input

The characteristics of polarographic electrodes make it necessary to exercise extreme care in connecting the *Model 1900* with the electrode set. The degree of difficulty involved depends upon the quality of the electrode, and the magnitude of the response relative to leakage currents and other sources of noise.

The polarographic electrode is connected directly to the **SENSOR** input. Many commercially available polarographic electrodes have BNC connectors, and may be used directly. Set the **SHIELD** and **REF** switches to the **GND** position for these electrodes. For electrodes with low responses in the pA range, particularly when maximal resolution is required, it may be necessary to drive the sensor cable shield, with the **SHIELD** switch in the **ACTIVE** position. This reduces possible leakage currents in the cabling by “bootstrapping” the cable shield to be at the same potential as the inner conductor. This is especially important if the polarization voltage is to be varied without readjusting the zero current. However, care must be taken to ensure that the shield is not otherwise connected to ground (or any other potentials) for the driven shield to work correctly. If this is not possible (or not necessary), the **SHIELD** switch must be set to **GND**.

The reference electrode is connected directly to the **REF** connector. Some electrodes incorporate a reference connection through the shield of the sensing electrode. In this case, set the **REF** switch to **GND**; no other reference is required. For the 3 electrode configuration, set the **REF** switch to **DIFF**. The return current path can be made either through the outer shield of the **REF** connector, or via the front panel **GND** connector. Some situations (particularly where space prohibits adding another electrode) require that all shields be connected together, and to ground. The **REF** switch should be set to **GND** in this case.

Controlling the Polarization Voltage

Polarographic electrodes need a bias voltage to ensure that they operate within their respective plateau regions. The *Model 1900* provides several options for solving this problem. For most situations, the **POLARIZATION** selector switch is used. Set the polarity to **INTERNAL+** or **INTERNAL-**, and adjust the voltage using the **INTERNAL VOLTAGE** control. The **EXT IN** signal is effectively disconnected in this mode. The polarization voltage can be observed on the panel **METER** by setting the **METER** switch to the **POLARIZATION** position. The readout is in mV. Oxygen electrodes are usually set at -600 mV, and hydrogen electrodes at +250mV. The polarization voltage may also be monitored via the **MONITOR OUT** connector.

For some situations, it may be desirable to set the polarization voltage from an external source, such as a computer controlled D/A converter. Simply set the **POLARIZATION** selector switch to **EXTERNAL**, and connect the source to the **EXT IN** connector. The **INTERNAL** voltage is disconnected in this mode. The polarization voltage may be monitored at the **METER** or at the **MONITOR OUT** connector.

Leaving the **GATE IN** connector disconnected is sufficient to guarantee that the specified polarization voltage appears at the polarographic electrode. If the **GATE IN** is driven low (e.g. by shorting the input to ground, or with a low TTL signal), the polarization voltage is turned off, and the voltage at the polarographic electrode is set to the same potential as the reference electrode. The polarization voltage available at **MONITOR OUT** reflects the state of the signal at **GATE IN**. However the **METER**, when set to **POLARIZATION** mode, always displays the polarization voltage regardless of the state of the signal at **GATE IN** so that the voltage can be set more easily without disturbing the electrode. The **OUTPUT** will continue to indicate the current flowing in the sensor electrode.

Setting the Output Mode

The type of output signal desired should be selected before beginning to calibrate the electrodes. You may switch between expanded and unexpanded modes (**%** and **% x10**; or **mmHg** and **mmHg x10**) without any complication, but switching between output types requires recalibration. This is necessary because no two electrodes are identical. Therefore, in general there is no interconvertibility of signal types, such as **CURRENT** and **mmHg**, except in the context of a specific electrode. However, switching between expanded and unexpanded modes, increasing gain when the signal dwindles, or decreasing gain to keep the signal within range may be done at any time. The **%** and **% x10** output modes may be used for scaling the output in kPa.

Calibrating the Electrode

If electrode current is of interest, no electrode calibration is necessary. Simply set the **ZERO CURRENT** to **OFF**, turn the **FINE GAIN** fully clockwise, and set the **NANOAMPERES** scale to the desired range. The *Model 1900* is calibrated and ready.

If the signal is to be displayed in **mmHg** or **%**, the electrode must be calibrated, since there are no “standard” electrodes. The *Model 1900* has been designed to ease some of the difficulty involved in calibrating electrodes. The following calibration procedure example uses the case of measuring oxygen dissolved in an aqueous environment. While a specific application may be different, the calibration procedure will likely be analogous.

In addition to the electrode set, cables, and the *Model 1900*, a method must exist to control the concentration of the substance being measured. The test solution should mimic the features of the tissue to be tested later. Important features to mimic may include both chemical and physical properties of the solution, such as temperature and osmolarity. Which features are important depends on the specificity of your electrode; that is, the degree to which the electrode is sensitive to factors other than those being

measured in the experiment. Consult the electrode manufacturer for further information regarding the sensitivity of the electrode any additional factors. A set of control experiments is advisable to safeguard against unforeseen interactions, and must be created with regard to the specific experiments to be conducted.

Sample Electrode Calibration Procedure

The first step is to calibrate the zero point. Set the **NANOAMPERS** switch to the desired range. It may be necessary to expose the electrode to a test solution with the maximum expected concentration first, in order to determine the maximal current. Connect the electrode set (2 electrode or 3 electrode) to the *Model 1900* as described above. The test solution should have as low a concentration of the substance as possible. It is highly desirable to achieve zero concentration, so that no interactive readjustment will be needed after setting the **FINE GAIN** later in this procedure. For the specific case of oxygen measurements, a warmed physiological saline solution can be depleted of oxygen by bubbling pure nitrogen gas through it. Ensure that the **ZERO CURRENT** switch is **ON**, and adjust the **FINE ZERO** control for a zero reading, either at the **OUTPUT** connector, or at the **METER** set to **OUTPUT**.

The second step is to calibrate the gain. Move the electrodes into a new solution (or change the concentration in the current solution) to have a known concentration. The selected concentration should be at or slightly greater than the maximum concentration which is expected in the experiment. Set the **FINE GAIN** control such that the reading is correct when observed at either the **METER** or the **OUTPUT** connector.

If it was possible to establish a true zero concentration, the electrodes are now stabilized. If the **NANOAMPERS** switch was not changed, the calibration is complete. Otherwise, this process should be repeated until no further adjustment is required. The degree of interaction is reduced as the low concentration solution approaches a zero concentration.

Display Meter and Output

The **METER** consists of a 3 1/2 digit display. The scale indication takes two forms: decimal point movement and LED range indication. These are driven from the condition of the **OUTPUT** selector switch and the **NANOAMPERS** selector switch. The display meter has an additional one-pole lowpass filter (bandwidth about 0.9 Hz), which does not influence the frequency response of the rest of the instrument.

The sign of the **METER** display (and the signal at the **OUTPUT** connector) is positive for (conventional) current flowing out of the input connector while the **OUTPUT** selector switch is set to **CURRENT**. Once the electrode set has been calibrated the measurements are available directly from the readout without further scaling. Voltages are scaled (within a decimal-point movement) and are simultaneously available at the **OUTPUT** connector)

Problem Solving

Most of the difficulties in making polarographic measurements are associated with imperfect electrodes. Ideally, the electrode will have a wide, perfectly horizontal plateau region, so that small variations in the polarization voltage will have no effect on the resultant current. In practice, this rarely occurs. The plateau region is generally tilted, and a plateau at one concentration may occur at a different polarization voltage than a plateau at a much different concentration. The polarization voltage should be chosen to pass through the flattest part of the plateau regions of interest.

Another problem associated with polarographic electrodes is the change in electrode characteristics with time and temperature. Temperature problems are minimized by maintaining a constant temperature while calibrating and taking the desired measurements. In most physiologically-related research, the application temperature is nearly constant. Applications in which temperature does vary significantly may require greater electrode characterization so that the desired measurements may be corrected for temperature effects after the experiment.

Electrode drift with time mostly occurs as a result of tissue penetration, but may also occur due to contamination by chemicals within the tissue being studied. Polarographic electrodes are often delicate; since less damage usually occurs on leaving the tissue than on penetration, it may be necessary to calibrate the electrodes after the experiment. The recorded results must then be modified appropriately. Electrode surface contamination by chemicals, especially tissue proteins, can occur which alter the redox potential of the electrode. This effect may be reduced by turning off the polarization voltage between measurements using a signal applied at the **GATE IN** connector to extinguish electrode current flow between measurements.

Solution movement over the sensor surface can change apparent electrode sensitivity ("stir artifact"). A greater degree of movement and a larger catalytic surface will produce a larger "stir artifact" effect. Membranes over the sensing surface greatly reduce this effect. The "Clark" oxygen electrode is a classic implementation of this approach.

To test the basic functionality of the *Model 1900*, replace the electrode with a 10 MV resistor. Set **REF** and **SENSOR** switches to the **GND** position. Use the **METER** to set an internal polarization voltage of +1.000 V as follows: set the **POLARIZATION** switch to **INTERNAL+**, disconnect any signals from the **GATE IN** and **EXT IN** connectors, set the **ZERO CURRENT** to **OFF**, switch the **METER** to **CURRENT**. The **METER** should read +100 nA (within the tolerance of the resistor and instrument). Switching the **POLARIZATION** to **INTERNAL-** should give reading of -100 nA. Finally, switching the **POLARIZATION** to **EXT** (with no signal applied at the **EXT IN** connected) or shorting the **GATE IN** connector should result in 0.0 nA.

The following chart includes a brief summary of typical problems encountered while using the *Model 1900*, along with the most common causes and solutions.

Problem

METER is dark

METER constantly blinks
(always overdriven)

METER reading does not change as
INTERNAL VOLTAGE control is rotated

METER does not respond to
concentration changes

Negative **METER** reading

Cause/Solution

- Blown fuse: replace fuse on back panel
- Improper power connection
- **SENSOR** input wire is shorted
- **REF** not connected properly
- **GND** connection missing while using **DIFF** (3 electrode) method
- **METER** switch not set to **POLARIZATION**
- **POLARIZATION** source switch set to **EXT**
- **GATE IN** is shorted or otherwise held "low"
- Nonfunctional or damaged electrode
- **METER** switch set to **POLARIZATION**
- **GATE IN** is shorted or otherwise held "low"
- **POLARIZATION** source is **EXT** but no input signal is applied
- Open circuit in **SENSOR** connection
- Nonfunctional or damaged electrode
- Excessive **ZERO CURRENT** compensation
- Negative **POLARIZATION** voltage in **CURRENT** mode

If the *Model 1900* appears to be malfunctioning, contact A-M Systems, Inc., or the dealer from which the instrument was purchased. Contact information for A-M Systems, Inc. is listed on the cover page of this manual. Further information may also be found in the section "Warranty and Service" in this manual.

Theory Of Operation

The operation of the *Model 1900* is summarized in the block diagram below (Figure 4). The most critical portion of the instrument is the Current to Voltage transducer (U100, U101, U102, U500A). This section accepts the polarization voltage, adds the reference voltage, and applies it to the input. At the same time, it detects the current flowing through the input port. It converts this current into a ground-referenced voltage which is passed to succeeding stages.

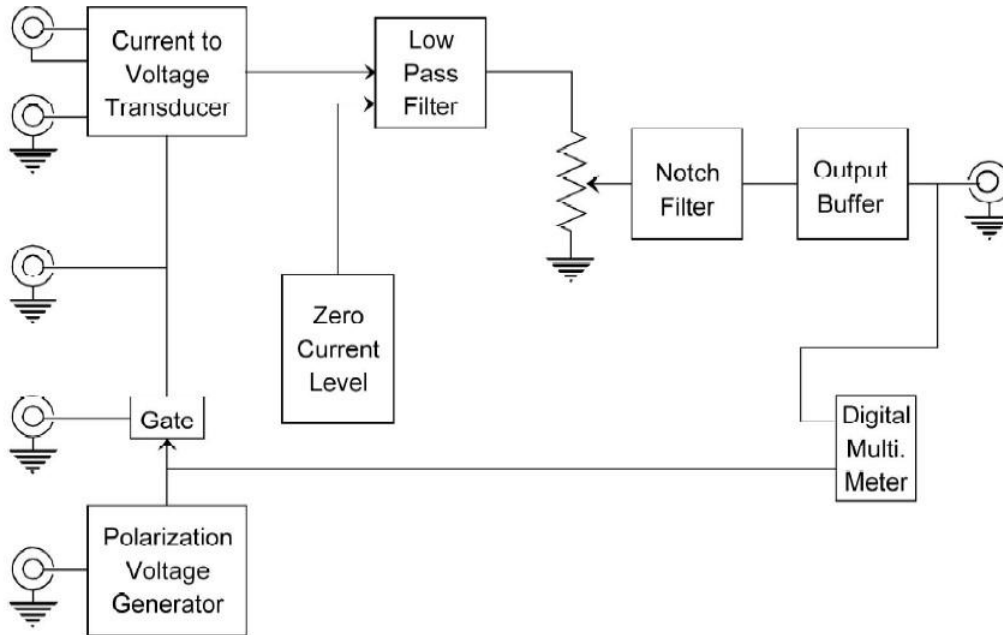

Figure 4. Instrument block diagram

The Polarization Generator generates and conditions a voltage suitable for the Current-to-Voltage Transducer. Internal polarity and amplitude are controlled, or an external polarization source is selected at this point. This signal is passed to the Meter and to the Gate. A buffered, gated polarization voltage is passed to the Current-to-Voltage Transducer and to the monitor output.

The low pass filter (approx. 15Hz, 2-pole transitional Butterworth-Thompson filter) subtracts the zero current signal from the output of the Current-to-Voltage Transducer, providing a method for eliminating the zero-concentration leakage current (and any other steady state leakage current as well). The sign of the zeroing current is automatically switched to oppose the input current flow, based on the sign of the polarization voltage. Gain is set at the output of the Low Pass Filter with a potentiometer. A high input impedance notch filter receives the output of the Gain

potentiometer, filters out line-frequency noise, and passes the result to an output buffer.

The output buffer is used to scale the signal, depending on the state of the output switch. For mmHg and % modes, the sign of the gain through this section is dependent on the sign of the polarization voltage in order to ensure that the output is always positive (although it is possible to force the output and meter negative for small input currents with large zero current signals).

Not included in the block diagram are the circuits controlling the LED and decimal point logic. The LED and decimal points are controlled based on the nanoamperes and output selector switch settings. The decimal points are suppressed when the meter is set to read the polarization voltage; the readout is then in mV.

Specifications

Input Section

Sensor Input

Offset current with ZERO CURRENT: OFF, SHIELD: ACTIVE	< ± 1.0 pA at 25°C ambient temperature < ± 4.0 pA at 40°C ambient temperature
---	--

Note: The input leakage is an internal value. It adds to the current flowing through any attached electrode. Additional leakages from exterior sources, including cables, may occur.

Input impedance	< $50 \Omega + 2 \mu\text{V} / (\text{scale current})$
Maximum continuous applied voltage (without breakdown)	$\pm 12 \text{ V}$

Sensor Shield

Shield driver output impedance	$5.2 \text{ k}\Omega \pm 5\%$
Shield driver output current	$> \pm 1 \text{ mA}$
Maximum continuous applied voltage (without breakdown)	$\pm 12 \text{ V}$

Reference Input

Input leakage current	< 300 pA at 25°C ambient temperature; 40 pA, typical
Input impedance with REF: DIFF	$10^{11} \Omega$, typical
Input impedance with REF: GND	< 2.0Ω
Voltage compliance range (offset between reference, gnd)	At least $\pm 2.5 \text{ V}$, referred to ground
Maximum continuous applied voltage (without breakdown)	$\pm 12 \text{ V}$

Polarization Section

Internal Voltage

Range	< 0.10 V to > 1.0 V
Settability	Within 1 mV of any value within the range
Accuracy	Within $\pm (1\% + 2 \text{ mV})$ of the potential indicated on the Meter
Drift	< $(0.02\% \text{ of setting/hour} + 100 \mu\text{V}/^\circ\text{C})$ after warmup period

External Input

Maximum linear range	$\pm 1.5 \text{ V}$
Input resistance	$1 \text{ M}\Omega \pm 1\%$
Accuracy	Within $\pm (0.2\% + 2 \text{ mV})$ of the potential indicated on the METER ; Within $\pm (1\% + 12 \text{ mV})$ of the potential applied at the connector

Gate Input

Gate ON condition	2.4 to 15.0 V (or open-circuit)
Gate OFF condition	-5.0 to 0.8 V (or short-circuit)
Input current	Less than $50\mu\text{A}$ is required to establish the OFF condition. More current may flow for gate control voltages above +5 V or below -2 V
Applied polarization voltage	Within $\pm 1.0 \text{ mV}$ of the reference potential with Gate OFF

Monitor Output

Output impedance	$1 \text{ k}\Omega \pm 2\%$
Accuracy	Within $\pm (2\% + 15 \text{ mV})$

Scaling

Step Gain Accuracy

The accuracy specifications are guaranteed only when the **SHIELD** switch set to **ACTIVE**, and do not include external error sources such as electrode non-linearity. The **FINE GAIN** control should be fully clockwise.

Full Scale Current	Accuracy ³ ± (% full scale + equivalent offset)
1000 nA	1% + 1.2 nA
100 nA	1% + 0.15 nA
10 nA	2% + 40 pA
1 nA	3% + 8.0 pA
0.1 nA	5% + 2.0 pA
Linearity (no expansion)	Within ± (0.1% of reading + 0.1% of full scale)
Linearity (with x10 expansion)	Within ± (0.25% of reading + 0.2% of full scale)

Fine Zero

Range < 0.01x to > 0.25x the full-scale setting

Settability Within 0.1% of the full-scale setting. This equals 0.1 pA in the 100 pA setting.

Fine Gain

The full clockwise position is 'calibrated' to the value on the step scaling control. Counter-clockwise rotation of this control reduces the output gain sensitivity.

Range < 0.1x to 1.00x the full-scale setting

Settability Within 0.2% of the full-scale setting

³. This applies at 25°C ambient temperature. Somewhat greater offsets may occur at higher temperatures. See the INPUT section for more details.

Output

Digital Panel Meter

Accuracy (**OUTPUT** mode) Within (0.1% of the range + 2 counts) of the output

Settling time (**OUTPUT** mode) < 1.0 sec to settle within 1.0%;
< 6 sec for the least significant digit to settle after a 100% scale

Total Drift and Noise

Initial offset ± 2 mV (± 5 mV for expanded scales)

Drift due to temperature < 0.05% of full-scale per °C after warm-up;
< 0.5% of full-scale per °C after warm-up for expanded scales

Drift due to time < 0.01% of full-scale/hour after warmup

Noise < 6 mV peak-to-peak at the output, measured with input open, 0.1 nA full-scale gain, **FINE GAIN** fully clockwise and 25°C ambient temperature (noise equivalent to < 0.6 pA peak-to-peak).

Dynamic Response

Bandwidth DC to 15 Hz (2-pole Low-Pass Filter, transitional Butterworth-Thompson)

Line rejection frequency < -45 dB in a 0.1 Hz band about the line frequency

Output impedance $100\Omega \pm 5\%$

Output Capability

Maximum output current ± 5 mA (minimum, short circuit)

Note: Higher output currents are available, but system accuracy is not guaranteed.

Warranty and Service

LIMITED WARRANTY

What does this warranty cover?

A-M Systems, LLC (hereinafter, “A-M Systems”) warrants to the Purchaser that the Instruments manufactured by A-M Systems (hereinafter the “hardware”), and sold after January 1, 2020, is free from defects in workmanship or material under normal use and service for the lifetime of the hardware. Headstages manufactured by A-M Systems and sold after January 1, 2020, will be repaired under warranty only once per year. This warranty commences on the date of delivery of the hardware to the Purchaser. “Lifetime” is defined as the time all components in the instrument can still be purchased from mainstream, common, electronic component distributors such as Digi-Key Electronics, Newark, or Mouser Electronics.

For hardware sold prior to January 1, 2020, the warranty in effect at time of purchase applies, with the maximum warranty period of three (3) years for new purchases, and one (1) year for those that have been repaired by A-M Systems. For headstages manufactured by A-M Systems and sold prior to January 1, 2020, the maximum warranty period is one (1) year.

What are the obligations of A-M Systems under this warranty?

During the warranty period, A-M Systems agrees to repair or replace, at its sole option, without charge to the Purchaser, any defective component part of the hardware. To obtain warranty service, the Purchaser must return the hardware to A-M Systems or an authorized A-M Systems distributor in an adequate shipping container. Any postage, shipping and insurance charges incurred in shipping the hardware to A-M Systems must be prepaid by the Purchaser, and all risk for the hardware shall remain with Purchaser until A-M Systems takes receipt of the hardware. Upon receipt, A-M Systems will promptly repair or replace the defective unit and then return the hardware (or its replacement) to the Purchaser with postage, shipping, and insurance prepaid by the Purchaser. A-M Systems may use reconditioned or like-new parts or units at its sole option, when repairing any hardware. Repaired products shall carry the same amount of outstanding warranty as from original purchase. Any claim under the warranty must include a dated proof of purchase of the hardware covered by this warranty. In any event, A-M Systems liability for defective hardware is limited to repairing or replacing the hardware.

What is not covered by this warranty?

This warranty is contingent upon proper use and maintenance of the hardware by the Purchaser and does not cover batteries. Neglect, misuse whether intentional or otherwise, tampering with or altering the hardware, damage caused

LIMITED WARRANTY, cont

by accident, damage caused by unusual physical, electrical, chemical, or electromechanical stress, damage caused by failure of electrical power, or damage caused during transportation are not covered by this warranty. Further, no guarantee is made regarding software compatibility with future updated operating systems. Products may not be returned to A-M Systems for service, whether under warranty or otherwise, which are contaminated by infectious agents, radioactive compounds or other materials constituting a health hazard to employees of A-M Systems

What are the limits of liability for A-M Systems under this warranty?

A-M Systems shall not be liable for loss of data, lost profits or savings, or any special, incidental, consequential, indirect or other similar damages, whether arising from breach of contract, negligence, or other legal action, even if the company or its agent has been advised of the possibility of such damages, or for any claim brought against you by another party.

THIS EQUIPMENT IS NOT INTENDED FOR CLINICAL MEASUREMENTS USING HUMAN SUBJECTS.

A-M SYSTEMS DOES NOT ASSUME RESPONSIBILITY FOR INJURY OR DAMAGE DUE TO MISUSE OF
THIS EQUIPMENT.

Jurisdictions vary with regard to the enforceability of provisions excluding or limiting liability for incidental or consequential damages. Check the provision of your local jurisdiction to find out whether the above exclusion applies to you.

This warranty allocates risks of product failure between the Purchaser and A-M Systems. A-M Systems hardware pricing reflects this allocation of risk and the limitations of liability contained in this warranty. The agents, employees, distributors, and dealers of A-M Systems are not authorized to make modifications to this warranty, or additional warranties binding on the company. Accordingly, additional statements such as dealer advertising or presentations, whether oral or written, do not constitute warranties by A-M Systems and should not be relied upon. This warranty gives you specific legal rights. You may also have other rights which vary from one jurisdiction to another.

THE WARRANTY AND REMEDY PROVIDED ABOVE IS IN LIEU OF ALL OTHER WARRANTIES AND REMEDIES, WHETHER EXPRESS OR IMPLIED. A-M SYSTEMS DISCLAIMS THE WARRANTIES OF MERCHANTABILITY AND FITNESS FOR A PARTICULAR USE, WITHOUT LIMITATION

Revision History

Rev	Date	Description
5	6/30/06	Initial Document Control release
6	4/28/10	DCR 201200 Warranty and company info
7	1/17/17	DCR 202465. Remove Calibration information.
8	1/18/19	DCR 202615. Review content. Add rev control to content.
9	3/19/20	DCR 203316. Update Warranty